

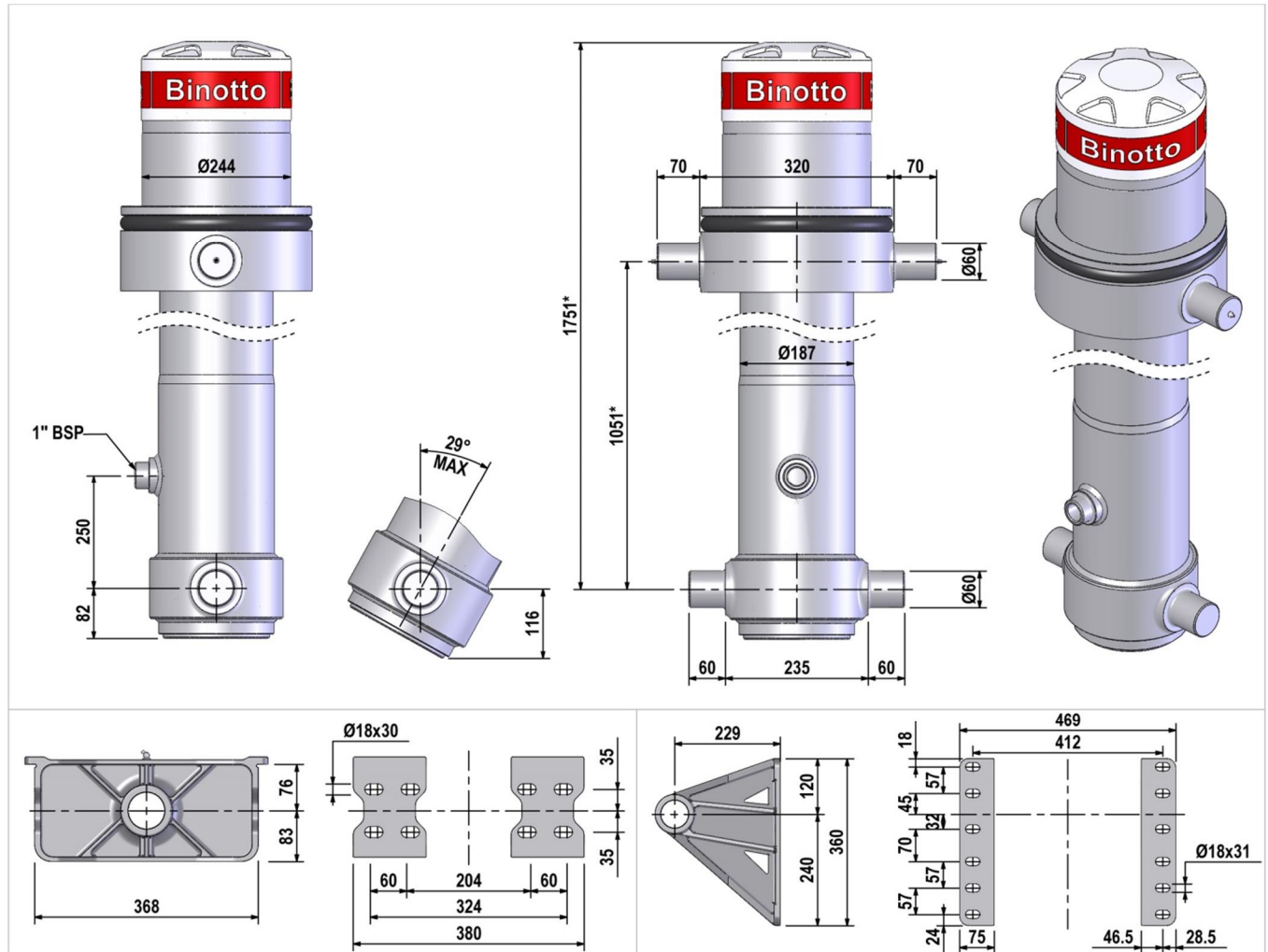

MOUNTING DIMENSIONS



TECHNICAL SPECIFICATIONS

Working Volume [lts]	92,6	Max. load (at first stage) [kN]	353
Max. Working Pressure [bar]	200	Max. extension speed [m/s] with ESV**	Less than 0,24***
Weight (cylinder + brackets) [kgs]	368	Max. extension speed [m/s] w/o ESV**	Less than 0,18***

\*Including 20 mm pull-out.

\*\*ESV= End of Stroke Valve.

\*\*\* For different requirements/applications please contact the Binotto Technical Department.

Stage n°	1	2	3	4	5					Total Stroke
Ø Stage [mm]	Ø165	Ø145	Ø126	Ø107	Ø088					7075
Stroke [mm]	1412	1412	1412	1412	1427					
Thrust at 200 Bar [kN]	419,3	323,8	244,5	176,3	119,3					

The application of a telescopic cylinder is to lift up tipping bodies, loaded with different materials, in order to discharge this material during its extension. • This cylinder is designed as a lifting device only for loads along the longitudinal axis. • It must not be used as a structural member or be subject to side load. • Hydraulic oil temperature allowable range between -40°C and +80°C. • Chromed thickness: minimum 20 µm • For standard version, max. duration of extension is 2 hrs. • Cylinder is painted gray (RAL 7021) with a thickness conforming to the 480 hours neutral salt spray test as per ISO 9227 (ISO 10289, rating 9). • The max tipping weight that can be raised by the cylinder is the body weight plus the max payload. This value, calculated at the max pressure, is a rough indication of the tipping power of the cylinder and must be used as a first criteria for the selection of the cylinder. • The real tipping mass can only be calculated by the design engineer of the dump truck, and must take into account the geometry of the dump body and operating conditions. • Never exceed maximum cylinder load. • Never exceed maximum pressure. • For Pump flow selection, contact the Binotto Technical Department.

REMARKS

REVISIONS

The cylinder must always be sold together with Quick Instructions (QI) and User Manual (MU). Make sure they are included and check them carefully before installation, usage, service or repair.